



classic mono LCDs

SPECIFICATION

GRAPHIC TYPE

DOT MATRIX LCD MODULE



ITEM NUMBER:

FECG240128A-FSWFBW-51YN

ESTABLISHED DATE:

2012.11

DATASHEET VERSION:

2008 VERSION

ISSUED BY:  **CHECKED BY:**  **APPROVED BY:** 

COPYRIGHT © 2000 ~ 2008 FORDATA ELECTRONIC CO., LTD. ALL RIGHTS RESERVED

- The following icons are absolutely designed by FORDATA independently in 2007-SEP. They are not in common use in the LCD industry yet but just used for marking out FORDATA products' characteristics quickly and simply without any special meaning. FORDATA reserves the composing right and copyright. No one else is allowed to adopt these icons without FORDATA's approval.
- The ISO9001 logo used in this document is authorized by SGS (www.sgs.com). FORDATA had already successfully passed the strict and professional ISO9001:2000 Quality Management System Certification and got the certificate (No.: CN07/00404)
- The technologies/techniques/crafts which denoted by the following icons are not exclusively owned by FORDATA, but also shared by FORDATA's LCD strategic cooperators, however all these technologies/techniques/crafts have been finally confirmed by FORDATA's professional engineers and QC department.
- As the difference in test standard and test conditions, also FORDATA's insufficient familiarity with the actual LCD using environment, all the referred information in this DATASHEET (including the icons) only have two functions:
 - 4.1: providing quick reference when you are judging whether or not the product meets your requirements.
 - 4.2: listing out definitely the tolerance.

FORDATA declares seriously: you should first test the corresponding sample(s) before signing the formal FORDATA SAMPLE APPROVAL document rather than consider this DATASHEET as the standard for judging whether or not the LCD meets your requirements. Once you instruct FORDATA to a mass-production without definite demand for providing sample before, FORDATA will disclaim all responsibility if the mass-production is proved not meeting with your requirements.

- The sequence of the icons is random and doesn't indicate the importance grade.
- Icons explanation



FORDATA's 2006 version logo. FORDATA is an integrated manufacturer of flat panel display (FPD). FORDATA supplies TN, HTN, STN, FSTN monochrome LCD panel; COB, COG, TAB LCD module; and all kinds of LED backlight.

classic mono LEDs



FAST RESPONSE TIME
 This icon on the cover indicates the product is with high response speed; Otherwise not.



PROTECTION CIRCUIT
 This icon on the cover indicates the product is with protection circuit; Otherwise not.



HIGH CONTRAST
 This icon on the cover indicates the product is with high contrast; Otherwise not.



LONG LIFE VERSION
 This icon on the cover indicates the product is long life version (over 9K hours guaranteed); Otherwise not.



WIDE VIEWING SCOPE
 This icon on the cover indicates the product is with wide viewing scope; Otherwise not.



Anti UV VERSION
 This icon on the cover indicates the product is against UV line. Otherwise not.



RoHS COMPLIANCE
 This icon on the cover indicates the product meets ROHS requirements; Otherwise not.

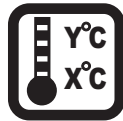

OPERATION TEMPERATURE RANGE
 This icon on the cover indicates the operating temperature range (X-Y).



3TIMES 100% QC EXAMINATION
 This icon on the cover indicates the product has passed FORDATA's thrice 100% QC. Otherwise not.



TWICE SELECTION OF LED MATERIALS
 This icon on the cover indicates the LED had passed FORDATA's twice strict selection which promises the product's identical color and brightness; Otherwise not.



V1cm = 3.0V
 This icon on the cover indicates the product can work at 3.0V exactly; otherwise not.



N SERIES TECHNOLOGY (2008 developed)
 FORDATA adopts new structure, new craft, new technology and new materials inside both LCD module and LCD panel to improve the "RainBow"

BOOKBINDING AREA



FORDATA ELECTRONIC CO.,LTD
PROFESSIONAL LCD SUPPLIER FROM CHINA

STANDARD
DOC.

REVISION RECORD

PAGE

1/21

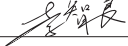
NO.	DATE	DESCRIPTION	ITEM	PAGE	APPROVED
1	2012.11	INITIAL ISSUED	ALL	ALL	

BOOKBINDING AREA



FORDATA ELECTRONIC CO.,LTD
PROFESSIONAL LCD SUPPLIER FROM CHINA

**STANDARD
DOC.**

CODE SYSTEM
STANDARD COB

PAGE

2/21

1	2	3	4	5	6	7	8	9	10	11	12	13	14	15	16
FD	C	C	08	01	A	F	L	Y	Y	B	W	5	2	L	E

No.	REMARKS	DESCRIPTION
1	COMPANY ABBRAVIATED	FD = FORDATA
2	IC packing	C = Chip On Board G = Chip On Glass T = TAB
3	LCM type	C = Character G = Graphic
4	Chyarakter	08, 10, 12, 16, 20, 24, 40, = Character number Per line
	Graphic	80, 100, 120, 122, 128, 160 = Row Dots Quantity
5	Character	01, 02, 04, = Character Lines
	Graphic	32, 64, 80, 128, 160 =Column Dots Quantity
6	Serial Number	A~Z
7	Polarizer type	R = Positive Reflective F = Positive Transflective M = Positive Transmissive N = Negative Transmissive E = Negative, Transflective B = Negative, Dual optical compensation (for FSTN type only)
8	Backlight type	N = No Backlight S = Edge Type LED Backlight L = Array Type LED Backlight F = EL backlight with Invertor E = EL backlight without Invertor T = CCFL backlight with Invertor C = CCFL backlight without Invertor
9	Backlight color	N = No Backlight Y = Yellow-Green W = White R = Red A = Amber C = Blue-Green B = Blue G = Green
10	LCD panel type	T = TN H = HTN Y = Yellow-Green STN G = Gray STN B = Blue STN F = FSTN
11	Viewing angle	B = Bottom 6:00 T = Top 12:00 R = Right 3:00 L = Left 9:00
12	Operation temperature range	S = 0°C ~ 50°C (Single Supply Voltage) D = 0°C ~ 50°C (Dual Supply Voltage) W = -20°C ~ 70°C (Single Supply Voltage) H = -20°C ~ 70°C (Dual Supply Voltage) T = -30°C ~ 80°C (Single Supply Voltage) E = -30°C ~ 80°C (Dual Supply Voltage)
13	Driving Voltage	1 : Vlcm = 3.0V, No / EL / CCFL Backlight or Vlcm = 3.0V, Vled = LED voltage, (Via AK) 2 : Vlcm = 3.6V, Vled = 5.0V (Not via AK) 3 : Vlcm = 3.6V, Vled = LED voltage, (Not via AK) 4 : Vlcm = 5.0V, Vled = LED voltage, (Not via AK) 5 : Vlcm = 5.0V, Vled = 5.0V (Not via AK) 6 : Vlcm = 5.0V, No / EL / CCFL Backlight or Vlcm = 5.0V, Vled = LED voltage, (Via AK) 7 : Vlcm = 3.6V, No / EL / CCFL Backlight or Vlcm = 3.6V, Vled = LED voltage, (Via AK) 8 : Vlcm = 3.0V, Vled = 5.0V 9 : Vlcm = 3.0V, Vled = LED voltage, (Not via AK)
14	Backlight Connect Method	0 = PIN1 LED-, PIN2 LED+ 1 = PIN15(17/19) LED+, PIN16(18/20) LED- 2 = PIN15(17/19) LED-, PIN16(18/20) LED+ 3 = PIN15(17/19) LED+, PIN16(18/20) NC 4 = PIN15(17/19) NC, PIN16(18/20) LED+ 5 = PINA LED+, PINK LED- 6 = No / EL / CCFL Backlight
15	IC Manufacturer	X = SAMSUNG L = SUNPLUS S = SITRONIX T = TOSHIBA E = EPSON H = HOLTEK Q = ASLIC N = CIMTEK P = PRINCETON
16	Font Set	R = English - Russia E = English - Japanese U = English - Europe H = English - Hebrew K = English - Europe N = NO FONT SET



1. GENERAL SPECIFICATIONS -----	Page 4
2. MECHANICAL SPECIFICATIONS -----	Page 4
3. ABSOLUTE MAXIMUM RATINGS -----	Page 4
4. ELECTRONICAL CHARACTERISTIC -----	Page 4
5. OPTICAL CHARACTERISTICS -----	Page 5
6. AC CHARACTERISTICS -----	Page 6
7. EXTERNAL DIMENSION-----	Page 7
8. PIN ASSIGNMENT -----	Page 8
9. BLOCK DIAGRAM -----	Page 8
10. POWER SUPPLY -----	Page 8
11. FLOWCHART OF COMMUNICATIONS WITH MPU -----	Page 9
12. COMMAND DEFINITIONS -----	Page 10
13. DESCRIPTION OF COMMAND-----	Page 11
14. CHARACTER MAP -----	Page 20
15. PACKING DETAIL -----	Page 21

BOOKBINDING AREA



FORDATA ELECTRONIC CO.,LTD
PROFESSIONAL LCD SUPPLIER FROM CHINA

PRODUCT SPEC.

MODE NO.
FECG240128A-FSWFBW-51YN

PAGE 4/21

1. GENERAL SPECIFICATIONS

ITEM	NOMINAL DIMENSIONS / AVAILABLE OPTIONS
DISPLAY FORMAT	240 X 128 DOT MATRIX
LCD PANEL OPTIONS	FSTN (Silver-gray color)
POLARIZER OPTIONS	Positive, Transflective
BACKLIGHT OPTIONS	Edge type LED backlight (White color)
VIEWING ANGLE OPTIONS	6:00 (Bottom)
TEMPERATURE RANGE OPTIONS	Wide temperature range (-20°C ~ 70°C)
CONTROLLER IC	RA6963+NT7086
DISPLAY DUTY	1/128
DRIVING BIAS	1/12

2. MECHANICAL SPECIFICATIONS

OVERALL SIZE	LED backlight version : 144.0 x 104.0 x max 12.1				mm
VIEWING AREA	114.0W x 64.0H	mm	HOLE-HOLE	138.0W x 97.0H	mm
DOT SIZE	0.40W x 0.40H	mm	DOT PITCH	0.05W x 0.05H	mm
WEIGHT (EL BKL)		g	WEIGHT (LED BKL)	145.0	g

3. ABSOLUTE MAXIMUM RATINGS

ITEM	SYMBOL	CONDITION	MIN	MAX	UNIT
POWER SUPPLY (LOGIC)	Vdd	25°C	-0.3	7.0	V
POWER SUPPLY (LCD)	V0	25°C	---	---	V
INPUT VOLTAGE	Vin	25°C	-0.3	Vdd +0.3	V
OPERATING TEMPERATURE	Vopr	---	-20	70	°C
STORAGE TEMPERATURE	Vstg	---	-30	80	°C

4. ELECTRONICAL CHARACTERISTIC*

ITEM	SYMBOL	CONDITION	STANDARD			UNIT
			MIN	TYP	MAX	
Input voltage	Vdd	+5V	4.7	5.0	5.5	V
Supply current	Idd	Vdd=5V	---	29.0	---	mA
Recommended LCD driving voltage for normal temp. Version module	Vdd - V0	-20°C	19.20	---	20.30	V
		0°C	17.70	---	18.70	
		25°C	16.40	---	17.30	
		50°C	14.90	---	15.60	
		70°C	13.90	---	14.30	
LED forward voltage	Vf	25°C	2.9	---	3.4	V
LED forward current	If	25°C	---	120	160	mA
LED reverse Current	Ir	25°C	---	80	---	µA
LED color range	X coordinate	25°C If = 120mA	0.25	---	0.28	---
	Y coordinate	25°C If = 120mA	0.26	---	0.29	---
LED illuminance (Without LCD)	Lv	25°C If = 120mA	300	---	450	cd/m ²
LED life time	---	25°C If = 120mA	9K**	---	---	Hours

* The above data are for reference only.

** The warranty period of FORDATA LCD module is 1YEAR counted from the date shown on the label of products.

** If you wanted to drive the LED BKL uninterruptedly exceed 12hours/day, you are not suggested this version

5. OPTICAL CHARACTERISTICS

FOR TN TYPE LCD MODULE (TA=25 °C, Vdd=5.0V ± 0.25V)						
ITEM	SYMBOL	CONDITION	MIN	TYP	MAX	UNIT
VIEWING ANGLE	$\Phi 2 - \Phi 1$	K=4	30	---	---	deg
	θ		25			
CONTRAST RATIO	K	---	---	2	---	---
RESPONSE TIME(RISE)	TR	---	---	120	150	ms
RESPONSE TIME(FALL)	TF	---	---	120	150	ms

FOR STN TYPE LCD MODULE (TA=25 °C, Vdd=5.0V ± 0.25V)						
ITEM	SYMBOL	CONDITION	MIN	TYP	MAX	UNIT
VIEWING ANGLE	$\Phi 2 - \Phi 1$	K=4	40	---	---	deg
	θ		60			
CONTRAST RATIO	K	---	---	6	---	---
RESPONSE TIME(RISE)	TR	---	---	150	250	ms
RESPONSE TIME(FALL)	TF	---	---	150	250	ms

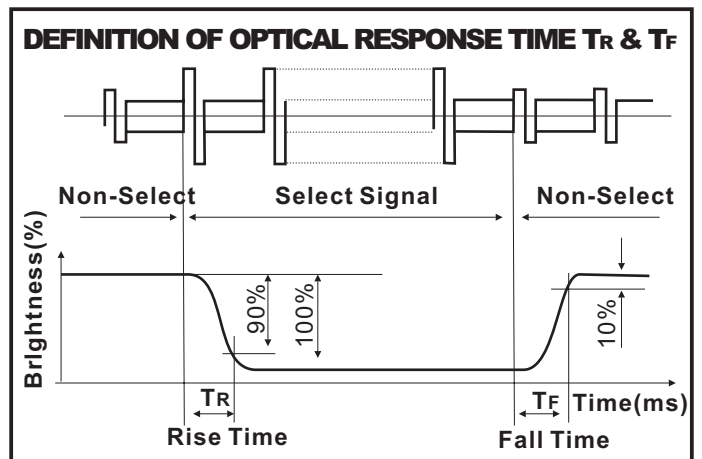
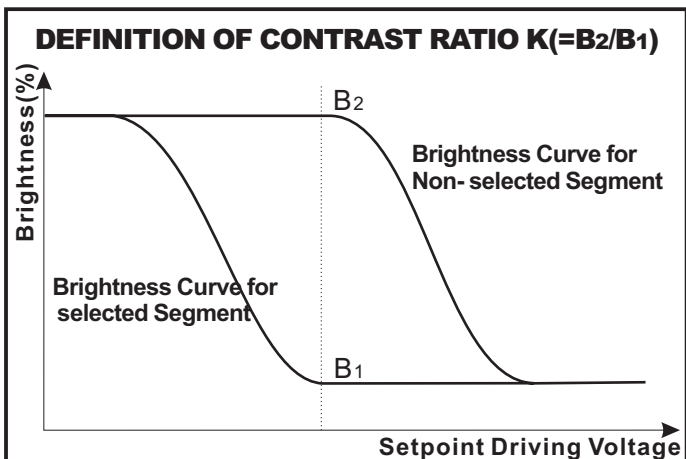
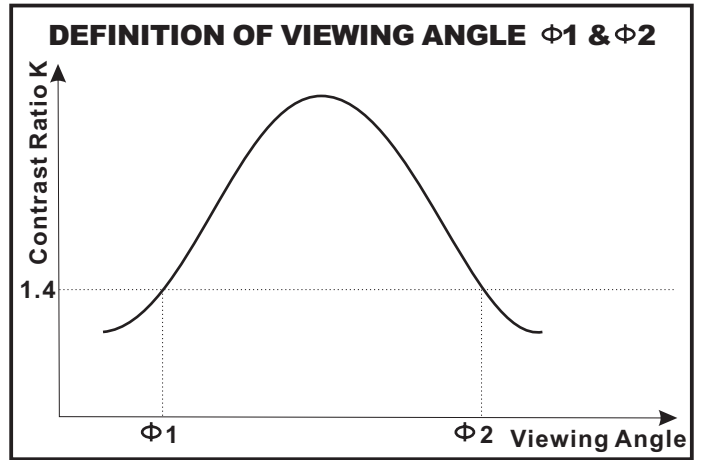
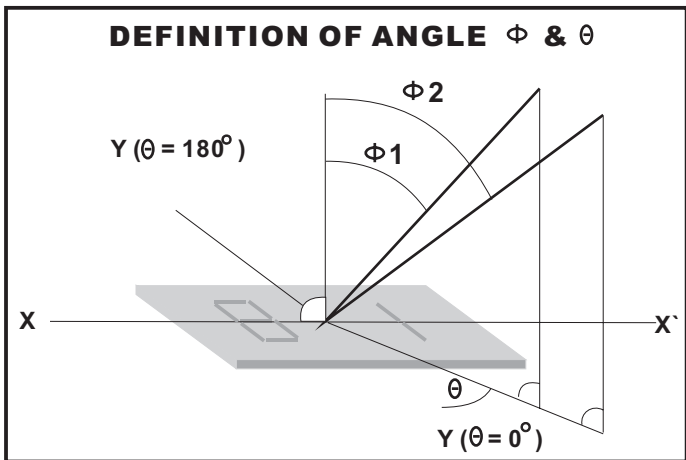



6.AC CHARACTERISTIC

ITEM	SYMBOL	MIN	MAX	UNIT
C/D Set-up Time	t_{CDS}	100	---	ns
C/D Hold Time	t_{CDH}	10	---	ns
\overline{CE} , \overline{RD} , \overline{WR} Pulse Width	t_{CE} , t_{RD} , t_{WR}	80	---	ns
Data Set-up Time	t_{DS}	80	---	ns
Data Hold Time	t_{DH}	40	---	ns
Access Time	t_{ACC}	---	150	ns
Output Hold Time	t_{OH}	10	50	ns

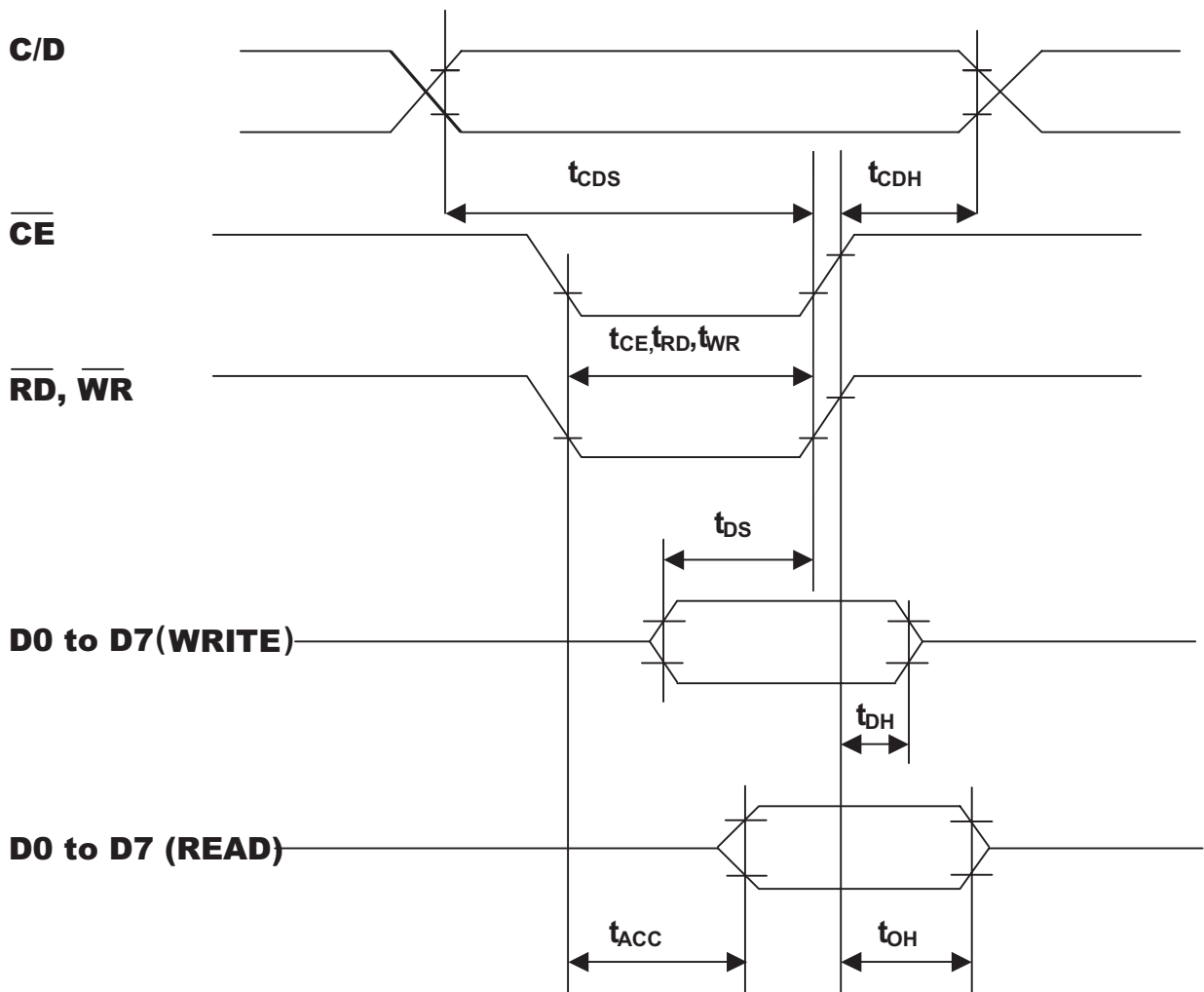

TEST CONDITIONS (Unless otherwise noted, $V_{DD}=5.0V \pm 10\%$, $V_{SS}=0V$, $T_a=-20^\circ C$ to $75^\circ C$)



7.EXTERNAL DIMENSIONS

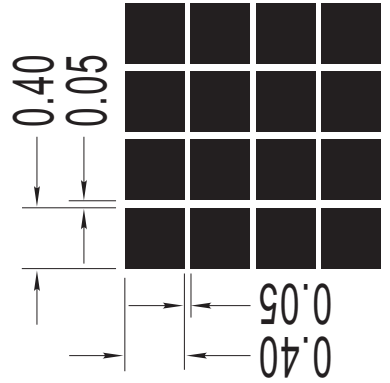
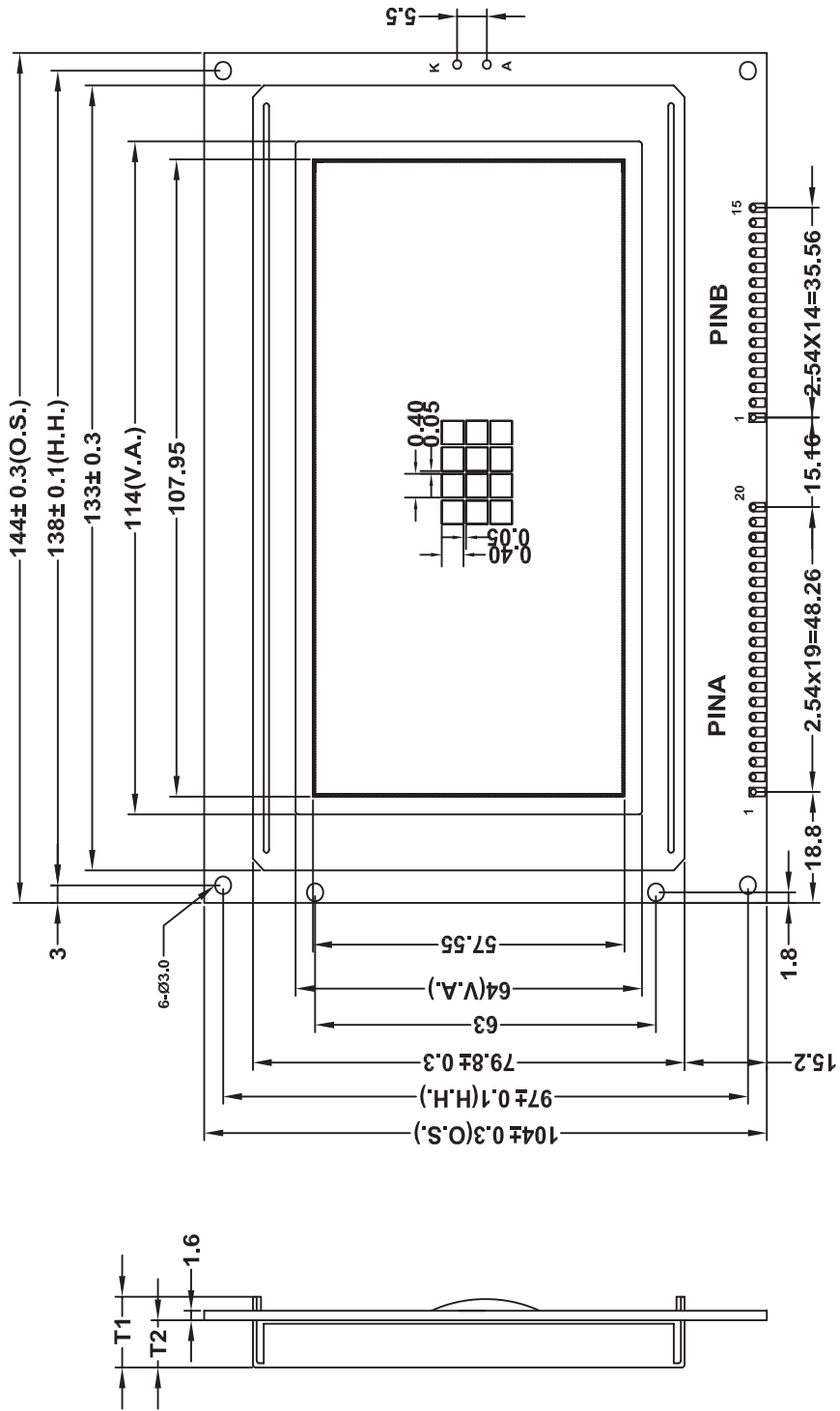

ITEM	T1	T2	UNIT
LED backlight	12.1	8.0	mm
EL or without backlight	---	---	mm

8. PINA ASSIGNMENT

PIN NO.	SYMBOL	FUNCTION	REMARK
1	Vee	Negative voltage output	
2	Vss	Power Supply	0V
3	Vdd		+5V
4	V0		Contrast Adjust
5	\overline{WR}	Data Write	
6	\overline{RD}	Data Read	
7	\overline{CE}	Chip Enable	
8	C/D	Command/DataSelect	
9	\overline{RST}	Reset Signal	
10	DB0	Data Bit 0	
11	DB1	Data Bit 1	
12	DB2	Data Bit 2	
13	DB3	Data Bit 3	
14	DB4	Data Bit 4	
15	DB5	Data Bit 5	
16	DB6	Data Bit 6	
17	DB7	Data Bit 7	
18	FS	Font Selection	
19	LED+	Anode of LED Unit	+5.0V
20	LED-	Cathode of LED Unit	0V

9. BLOCK DIAGRAM

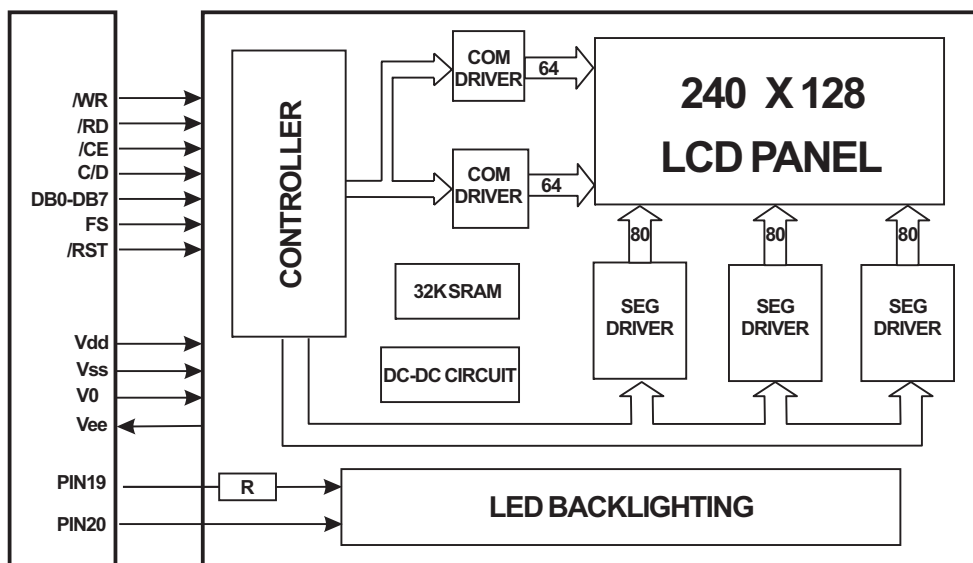

10. POWER SUPPLY

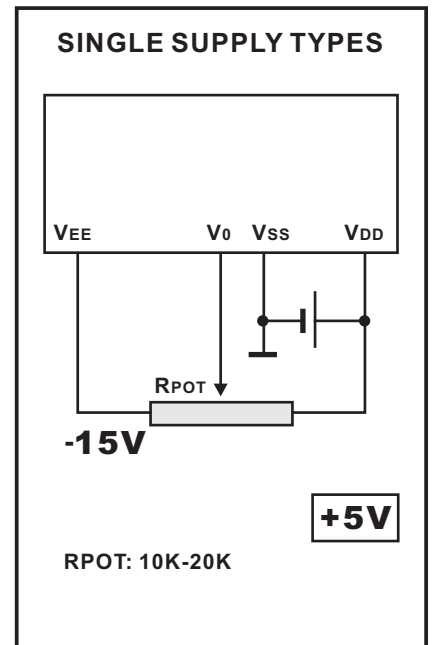



11. FLOWCHART OF COMMUNICATIONS WITH MPU

Status Word

MSB

LSB

STA7 D7	STA6 D6	STA5 D5	STA4 D4	STA3 D3	STA2 D2	STA1 D1	STA0 D0
------------	------------	------------	------------	------------	------------	------------	------------

STA0	Check command execution capability	0:Disable 1:Enable
STA1	Check data read / write capability	0:Disable 1:Enable
STA2	Check auto mode data read capability	0:Disable 1:Enable
STA3	Check auto mode data write capability	0:Disable 1:Enable
STA4	Not used	
STA5	Check controller operation capability	0:Disable 1:Enable
STA6	Error flag. Used for Screen Peek and Screen copy commands	0:No error 1:Error
STA7	Check the blink condition	0:Dsiplayoff 1:Normal display

Note 1 : A status check must be performed before data is read or written.

Note 2 : It is necessary to check STA0 and STA1 at the same time.

There is a possibility of erroneous operation due to a hardware interrupt .

Note 3 : For most modes STA0 / STA1 are used as a status check.

Note 4 : STA2 and STA3 are valid in Auto mode; STA0 and STA1 are invalid.

Setting Data

A) The case of 1 data

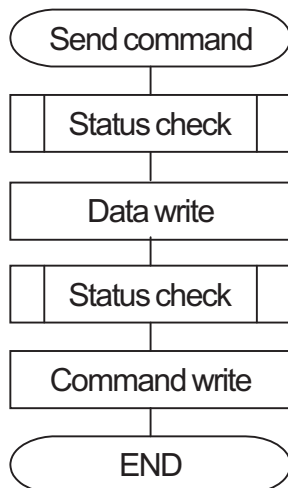

B) The case of 2 data

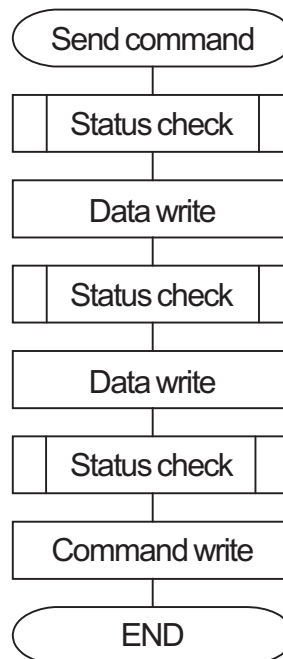



12. COMMAND DEFINITIONS

COMMAND	CODE	D1	D2	FUNCTION
REGISTERS SETTING	00100 0 0 1 00100 0 1 0 00100 1 0 0	X address Data Low address	Y address 00H High address	Set Cursor Pointer Set Offset Register Set Address Pointer
SET CONTROL WORD	01000 0 0 0 01000 0 0 1 01000 0 1 0 01000 0 1 1	Low address Columns Low address Columns	High address 00H High address 00H	Set Text Home Address Set Text Area Set Graphic Home Address Set Graphic Area
MODE SET	1000X 0 0 0 1000X 0 0 1 1000X 0 1 1 1000X 1 0 0 10000 XXX 10001 XXX	---	---	OR mode EXOR mode AND mode Text Attribute mode Internal CG ROM mode External CG RAM mode
DISPLAY MODE	10010 0 0 0 1001XX 1 0 1001XX 1 1 10010 1 XX 10011 0 XX 10011 1 XX	---	---	Display off Cursor on, blink off Cursor on, blink on Text on, graphic off Text off, graphic on Text on, graphic on
CURSOR PATTERN SELECT	10100 0 0 0 10100 0 0 1 10100 0 1 0 10100 0 1 1 10100 1 0 0 10100 1 0 1 10100 1 1 0 10100 1 1 1	---	---	1-line cursor 2-line cursor 3-line cursor 4-line cursor 5-line cursor 6-line cursor 7-line cursor 8-line cursor
DATA AUTO READ/WRITE	10110 0 0 0 10110 0 0 1 10110 0 1 0	---	---	Set Data Auto Write Set Data Auto Read Auto Reset
DATA READ/WRITE	11000 0 0 0 11000 0 0 1 11000 0 1 0 11000 0 1 1 11000 1 0 0 11000 1 0 1	Data --- Data --- Data ---	---	Data Write and Increment ADP Data Read and Increment ADP Data Write and Decrement ADP Data Read and Decrement ADP Data Write and Non-variable ADP Data Read and Non-variable ADP
SCREEN PEEK	11100 0 0 0	---	---	Screen Peek
SCREEN COPY	11101 0 0 0	---	---	Screen Copy
BIT SET/RESET	11110 XXX 11111 XXX 1111X 0 0 0 1111X 0 0 1 1111X 0 1 0 1111X 0 1 1 1111X 1 0 0 1111X 1 0 1 1111X 1 1 0 1111X 1 1 1	---	---	Bit Reset Bit Set Bit 0 (LSB) Bit1 Bit2 Bit3 Bit4 Bit5 Bit6 Bit 7 (MSB)

Note: First set the data, then set the command.



13. Description of Command

Setting Registers

(1) Set Cursor Pointer

The position of the cursor is specified by X ADRS and Y ADRS. The cursor position can only be moved by this command . Data read / write from the MPU never changes the cursor pointer

X ADRS: 00H to 4FH(lower 7 bits are valid); Y ADRS: 00H to 1FH (lower 5 bits are valid)

a) Single-Scan

X ADRS 00 to 4FH

Y ADRS 00H to 0FH

b) Dual-Scan

X ADRS 00H to 4FH

Y ADRS 00H to 0FH
Upper screen

Y ADRS 10H to 1FH
Lower screen

(2) Set Offset Register

The offset register is used to determine the external character generator RAM are.

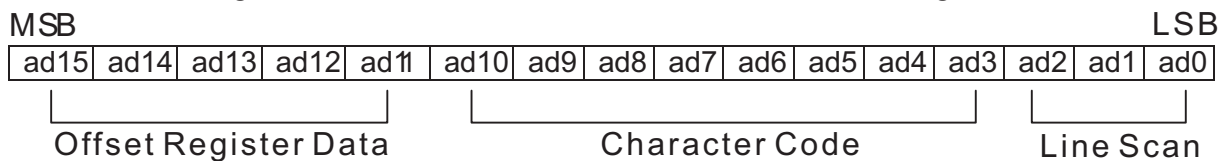

The senior five bits define the start address in external memory of the CG RAM area. The next eight bits represent the character code of the character. In internal CG ROM mode, character codes 00H to 7FH represent the predefined internal CG ROM characters, and codes 80H to FFH represent the users own external characters. In external CG RAM mode, all 256 codes from 00H to FFH can be used to represent the users own characters.

The three least significant bits indicate one of the eight rows of eight dots that define the characters shape.

The relationship between display RAM address and offset register.

Offset register data	CG RAM hex. Address (start to end)
00000	0000to 07FFH
00001	0800to 0FFFH
00010	1000to 17FFH
11100	E000to E7FFH
11101	E800to EFFFH
11110	F000to F7FFH
11111	F800to FFFFH



Example 1:

Offset register	02H
Character code	80H
Character Generator RAM start address	0001 0100 0000 0000
	1 4 0 0 H

	(address)	(data)
	1400H	00H
	1401H	1FH
	1402H	04H
	1403H	04H
	1404H	04H
	1405H	04H
	1406H	04H
	1407H	00H

Example 2:

The relationship between display RAM data and display characters:

	(RAM DATA)	(CHARACTER)
A E Y D E ζ G H U K L M	21H	A
	22H	B
	83H	Y
	24H	D
Display character	25H	E
	86H	ζ

* Y and ζ are displayed by Character Generator RAM

(3) SetAddress Pointer

The SetAddress Pointer command is used to indicate the start address for writing to (or reading from) external RAM.

The flowchart for SetAddress Pointer command:

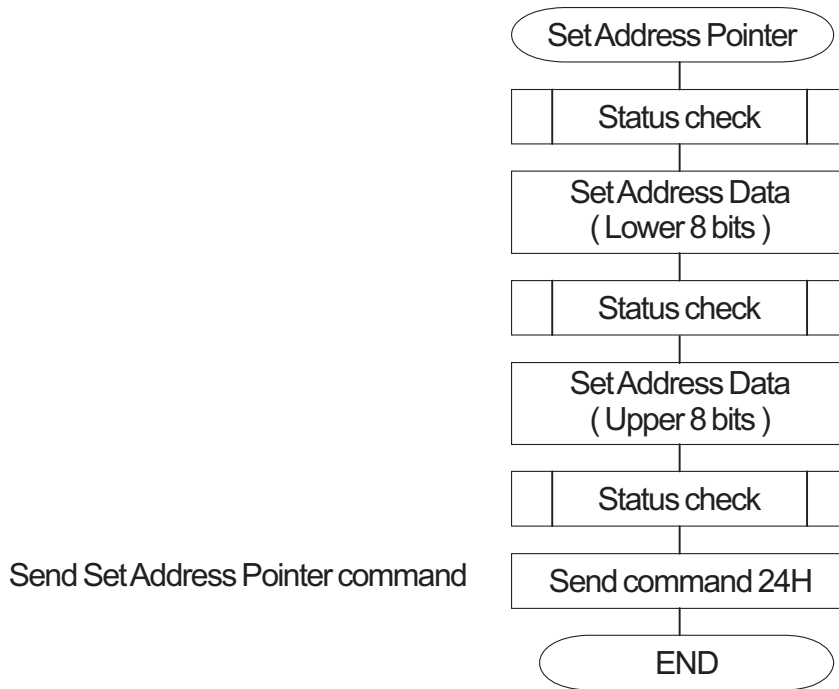

Set Control Word

The home address and column size are defined by this command.

(1) Set Text Home Address

The starting address in the external display RAM for text display is defined by this command. The text home address indicates the left most and uppermost position. The relationship between external display RAM address and display position.

TH	-----	TH + CL
TH + TA	-----	TH + TA + CL
(TH + TA) + TA	-----	TH + 2TA + CL
-----	-----	-----
TH + (N - 1)TA	-----	TH + (N - 1)TA + CL

TH: Text home address TA: Text area number (columns)

CL: Columns are fixed by hardware (pin-programable).

Example :

Text home address: 0000H Text area: 0020H

MD2 = H, MD3 = H: 32 columns DUAL = H, MDS = L, MD0 = L, MD1 = H; 4 lines

0000H	0001H	-----	001EH	001FH
0020H	0021H	-----	003EH	003FH
0040H	0041H	-----	005EH	005FH
0060H	0061H	-----	007EH	007FH



(2) Set Graphic Home Address

The starting address of the external display RAM used for graphic display is defined by this command. The graphic home address indicates the leftmost and upper most position. The relationship between external display RAM address and display position.

GH	-----	GH + CL
GH + GA	-----	GH + GA + CL
(GH + GA) + GA	-----	GH + 2GA + CL
-----	-----	-----
GH + (N - 1)GA	-----	GH + (N - 1)GA + CL

GH : Graphic home address GA: Graphic area number (columns)
CL : Columns are fixed by hardware (pin-programmable)

Example

Graphic home address : 000H Graphic area : 0020H
MD2 = H, MD3 = H; 32 columns DUAL = H, MDS = L, MD0 = H, MD1 = H; 2lines

0000H	0001H	-----	001EH	001FH
0020H	0021H	-----	003EH	003FH
0040H	0041H	-----	005EH	005FH
0060H	0061H	-----	007EH	007FH
0080H	0081H	-----	009EH	009FH
00A0H	00A1H	-----	00BEH	00BFH
00C0H	00C1H	-----	00DEH	00DFH
00E0H	00E1H	-----	00FEH	00FFH
0100H	0101H	-----	011EH	011FH
0120H	0121H	-----	013EH	013FH
0140H	0141H	-----	015EH	015FH
0160H	0161H	-----	017EH	017FH
0180H	0181H	-----	019EH	019FH
01A0H	01A1H	-----	01BEH	01BFH
01C0H	01C1H	-----	01DEH	01DFH
01E0H	01E1H	-----	01FEH	01FFH

(3) Set Text Area

This command can be used to define the columns of the test display.

Example

LCD size: 20columns , 4lines Text home address: 0000H
Text area: 0014H MD2 = H, MD3 = H; 32 columns
DUAL = H, MDS = L, MD0 = L, MD1 = H; 4lines

0000	0001	-----	0013	0014	-----	001F
0014	0015	-----	0027	0028	-----	0033
0028	0029	-----	003B	003C	-----	0047
003C	003D	-----	004F	0050	-----	005B





(4) Set Graphic Area

This command can be used define the columns of the graphic display

Example : LCD size: 20columns , 2lines Graphic home address: 0000H
 Graphic area: 0014H MD2 = H, MD3 = H; 0014H

DUAL = H, MDS = L, MD0 = H, MD1 = H; 2lines

0000	0001	-----	0013	0014	-----	001F
0014	0015	-----	0027	0028	-----	0033
0028	0029	-----	003B	003C	-----	0047
003C	003D	-----	004F	0050	-----	005B
0050	0051	-----	0063	0064	-----	006F
0064	0065	-----	0077	0078	-----	0083
0078	0079	-----	008B	008C	-----	0097
008C	008D	-----	009F	00A0	-----	00AB
00A0	00A1	-----	00B3	00B4	-----	00BF
00B4	00B5	-----	00C7	00C8	-----	00D3
00C8	00C9	-----	00DB	00DC	-----	00E7
00DC	00DD	-----	00EF	00F0	-----	00FD
00F0	00F1	-----	0103	0104	-----	011F
0104	0105	-----	0127	0128	-----	0123
0128	0129	-----	013B	013C	-----	0147
013C	013D	-----	014F	0150	-----	015B



Mode Set

The display mode does not change until the next command is sent. In Internal Character Generator mode, character codes 00H to 7FH are assigned to the built - in Character Generator RAM. The character codes 80H to FFH are automatically assigned to the external Character Generator RAM

Example : (Note: Attribute functions can only be applied to text display , since the attribute data is placed in the graphic RAM area.)

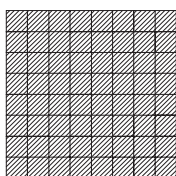

GRAPHIC

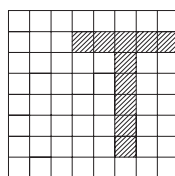

TEXT

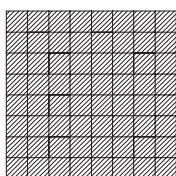

OR

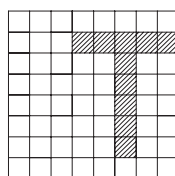

AND

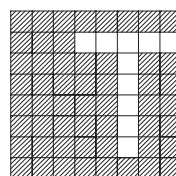

EXOR



Attribute Function

The attribute operations are reverse display, character blink and inhibit. The attribute data is written into the graphic area which was defined by the Set Control Word command. Only text display is possible in attribute function mode; graphic display is automatically disabled. However, the Display Mode command must be used to turn both Text and Graphic on in order for the Attribute Function to be available.

Attribute RAM 1 byte

X	X	X	X	d3	d2	d1	d0
---	---	---	---	----	----	----	----

d3	d2	d1	d0	FUNCTION
0	0	0	0	Normal display
0	1	0	1	Reverse display
0	0	1	1	Inhibit display
1	0	0	0	Blink of normal display
1	1	0	1	Blink of reverse display
1	0	1	1	Blink of inhibit of display

X: invalid

Display Mode

It is necessary to turn on Text display and Graphic display in the following cases

- a) Combination of text / graphic display
- b) Attribute function

Cursor Patten Select

When cursor display is ON, this command selects the cursor pattern in the range 1 line to 8 lines. The cursor address is defined by the Cursor Pointer Set command.

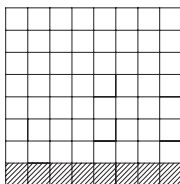

1-line cursor

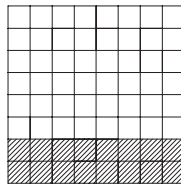

2-line cursor

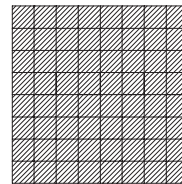

8-line cursor



Data Auto Read / Write

This command is convenient for sending a full screen of data from the external display RAM. After setting Auto mode, a Data Write (or Read) command is need not be sent between each datum. A data Auto Write (or Read) command must be sent after a set Address Pointer command. After this command, the address pointer is automatically incremented by 1 after each datum. In Auto mode, the LCM cannot accept any other commands. The Auto Rest command must be sent to the LCM after all data has been sent to clear Auto mode.

Data Read / Write

This command is used for writing data from the MPU to external display RAM , and reading data from external display RAM to the MPU. Data Write / Read should be executed after setting address using SetAddress Pointer command. The address pointer can be automatically incremented or decrement using this command.

Note: This command is necessary for each 1-byte datum.

Refer to the following flowchart.

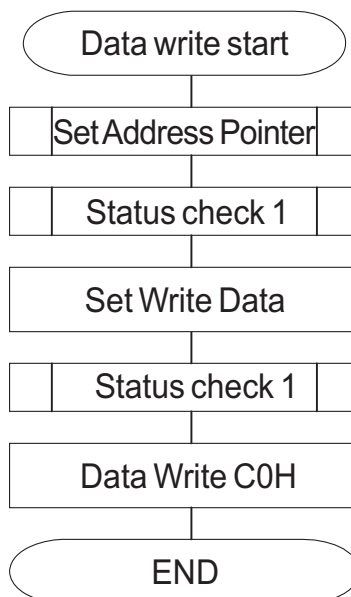



Screen Peek

The command is used transfer 1 byte of displayed data to the data stack , this byte can then be read from the MPU by data access. The logical combination of text and graphic display data on the LCD screen can be read by this command.

The status (STA6) should be checked just after the Screen Peek command. If the address determined by the Set Address Pointer command. Is not in the graphic area, this command is ignored and a status flag (STA6) is set.

Refer to the following flowchart

Note: This command is available when hardware column number and software column number are the same. Hardware column number is related to MD2 AND MD3 setting. Software column number is related to Set Text Area and Set Graphic Area command.

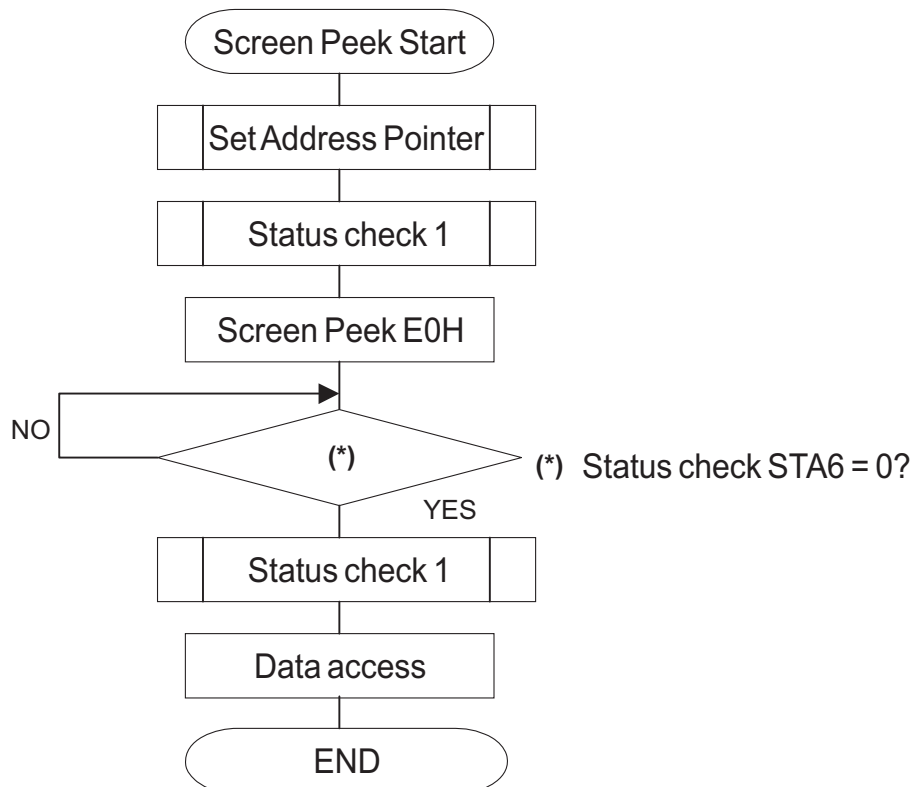

(Note) This command is available when hardware column number and software column number are the same. Hardware column number is related to MD2 and MD3 setting. Software column number is related to Set Text Area and Set Graphic Area command.



Screen Copy

This command copies a single raster line of data to the graphic area.

The start point must be set using the Set Address Pointer command.

Refer to the following flowchart.

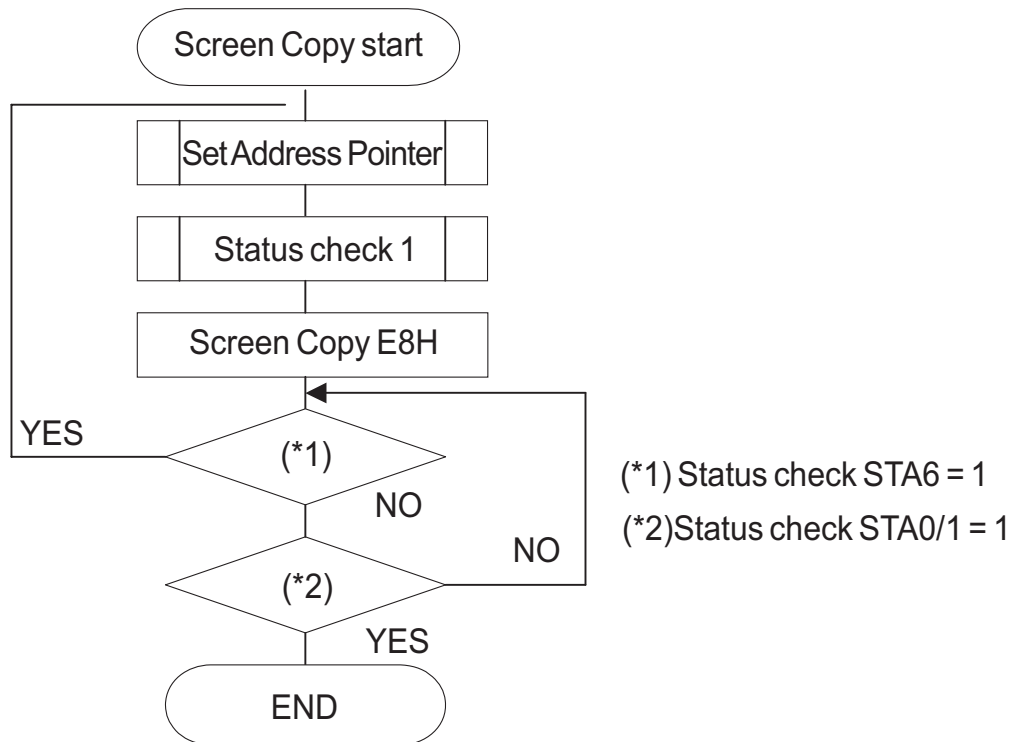

Note 1 : If the attribute function is being used, this command is not available. (With attribute data is graphic area data).

Note 2 : With Dual -Scan, this command cannot be used (because the LCM cannot separate the upper screen data and lower screen data).

Note 3 : This command is available when hardware column number and software column number are the same.

Bite Set/Reset

This command use to set or reset a bit of the byte specified by the address pointer. Only one bit can be set/reset at a time.

Refer to the following flowchart.

14. CHARACTER MAP

ROM Code 0101

LSB MSB	0	1	2	3	4	5	6	7	8	9	A	B	C	D	E	F
0																
1																
2																
3																
4																
5																
6																
7																

BOOKBINDING AREA

 FORDATA ELECTRONIC CO.,LTD PROFESSIONAL LCD SUPPLIER FROM CHINA	PRODUCT SPEC.	MODE NO.	PAGE 21/21
		FECG240128A-FSWFBW-51YN	

15. PACKING DETAIL

WITH LED BKL	WITHOUT LED BKL
16 PCS/BOX	16 PCS/BOX
8 BOXES/CARTON	8 BOXES/CARTON
128 PCS/CARTON	128 PCS/CARTON
27.00 KGS/CTN(G.W.)	24.00 KGS/CTN(G.W.)
0.07 M ³ /CARTON	0.07 M ³ /CARTON

NOTE
1. The weight is estimated for reference only.
2. Packing detail may be changed without notice.

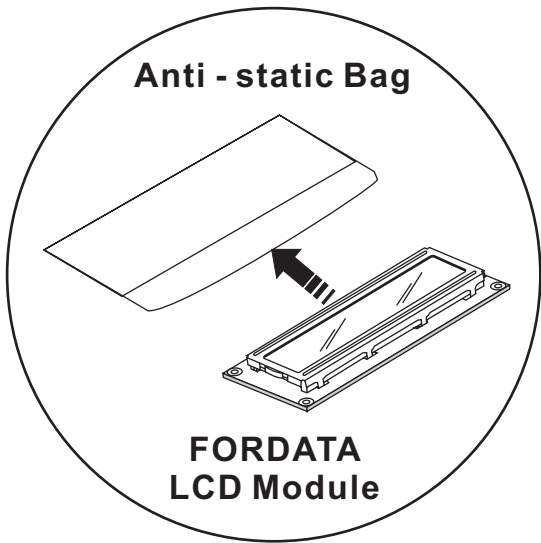

BOX 

CARTON 

