

产品规格书

PRODUCT SPECIFICATION

客 户	客户名称/Customer	
	客户料号/Part No.	
	客户承认签章 Customer Approved Signatures	

敝 司	文件编号/Spec No.	KOTL-S08078	
	品名 Description	扁平振动马达 Coin Vibration Motor	
	型号/Model	C1020B008F1	
	送样日期/Date		
	设计/Designed	审核/checked	批准/Approved
	王宗雄 2008.04.14	付梅章 2008.04.14	邵家声 2008.04.14

地址：中国浙江省温州乐清北白象金龙科技园

Add: Jinlong Science and Technology Park, Jingang
 Road, Beibaixiang, Yueqing, Wenzhou Zhejiang, China

电话/Tel: 86-577-61801678 61806666 传真/ Fax: 86-577-61801858

[Http://www.kotl.com.cn](http://www.kotl.com.cn)

规格书内容

Contents of specifications

1. 适用范围/Application	1/8
2. 使用条件/Operating Condition	1/8
3. 测试条件/Test Condition	1/8
4. 初期电气性能/Electrical initial characteristics	1/8
5. 机械性能/Mechanical characteristics	2/8
6. 耐久性能/Durability characteristics	2/8
7. 要求/Requires	3/8
8. 使用注意事项/Caution for use	5/8
9. 包装/Packing	6/8
10. 外形图/Outside View	7/8
11. 更改记录/Revised record	8/8

1. 适用范围/General

本说明书适用于扁平式永磁直流电机 C1020B008F1 系列.

This specification applies to coin permanent-magnetic motors DC model C1020B008F1 series

2. 使用条件/Operating condition

项目/Item		规格/Specification
2-1	额定电压 Rated voltage	3.0V DC
2-2	使用电压范围 Operating voltage	2.7~3.3V DC
2-3	旋转方向 Rotation	CW(clockwise) or CCW(contrary clockwise)
2-4	使用环境 Operating environment	-20~+60℃, Ordinary Humidity
2-5	保存环境 Storage environment	-30~+70℃, Ordinary Humidity

3. 测定条件/Measuring condition

项目/Item		规格/Specification
3-1	温度 Temperature	25±3℃
3-2	湿度 Humidity	65±20% RH
3-3	气压 Air pressure	1013±40 hPa
3-4	电源电压 Power supply & Voltage	直流电源或电池 3.0V DC Power supply or Battery 3.0 (V)

4. 初期电气性能/Electrical initial characteristics

项目/Item		规格/Specification	条件/Condition
4-1	额定转速 Rated speed	9000rpm min	额定电压下 At rated voltage
4-2	额定电流 Rated current	90mA Max	
4-3	起动电流 Starting current	120mA Max	在最小起动电压下起动 Motor is rotating at min starting voltage.
4-4	起动电压 Starting voltage	2.3V DC Max	
4-5	绝缘电阻 Insulation resistance	10MΩ Min	在 100V 直流下, 导线和机壳间 At DC 100V between lead wire and case.
4-6	端子阻抗 Terminal resistance	31Ω ±15%(单相 sigle posture) 59Ω ±15%(双相 compose posture)	在 25℃ 下 At 25℃

5. 机械性能/Mechanical characteristics

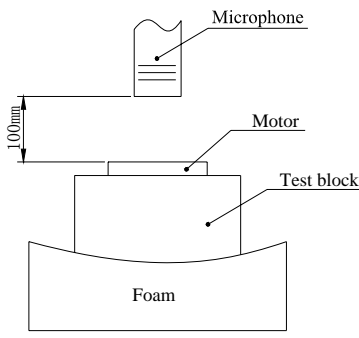
项目/Item	规格/Specification
5-1 底盖偏转强度 Bracket deflection strength	9.8N 以上 9.8N or more
5-2 机械噪音 Mechanical noise	小于 50 分贝. A 计权 50dB(A) Max
<p>在额定电压下。 At rated voltage 背景噪音：不大于 28dB. A 计权 Back ground noise 28dB(A) Max</p> 	

6. 耐久性能/Durability characteristics

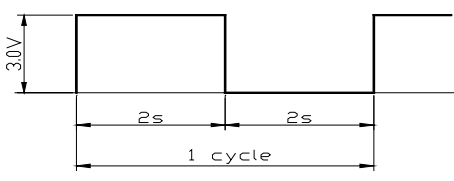
项目/Item	规格/Specification	判定标准/Judgment
6-1 寿命 Life	 <p>试验循环 /Test cycle: 50,000 cycles</p>	<p>试验后，马达应符合项 7-1 的要求。 After the test, motors shall be approved as specified in item 7-1.</p>

项目/Item		规格/Specification		判定标准/Judgment
6-2	低温放置 Low temp exposure	温度 时间	/Temperature : -30°C /Time : 96h	在常温常湿下放置 4h 后, 马达应符合项 7-2 的要求。 After 4 hours exposure in ordinary temperature and humidity, Motors shall be approved as specified in item 7-2.
6-3	高温放置 High temp. Exposure	温度 时间	/Temperature : +70°C /Time : 96h	
6-4	湿度放置 Humidity exposure	温度 湿度 放置时间 无水气凝结/No condensation of moisture	/Temperature : +40°C /Humidity : 95%RH / Exposure time : 96h	
6-5	振动 Vibration	全振幅 频率 加速度 周期 条件	/Displacement : 1.5mm (p-p) /Frequency : 10 ~ 55Hz /Acceleration : 22m/s ² /Period : 10min 范围内 (10~55~10Hz) /10 Minutes log sweep (10~55~10Hz) /Condition :	测试结果应符合项 7-2 的要求。 After the test motors shall be approved as specified in item 7-2.
6-6	自然跌落 Free fall	试验状态/Test state: 高度 方向 次数 冲击	将马达固定在约 100 克 (包括马达本身) 的物体上, 落向水泥地面。 Set the motor to the approximately 100g (include the motor) weight of block drop the motor on the concrete floor. /Height : 1.5m /Direction : ±x. ±y. ±z /Number of times: 每个方向 3 次 /Each 3 times /Shock : 29420m/s ² 相当 /Equivalent (3000G)	测试结果应符合项 7-2 的要求。 After the test motors shall be approved as specified in item 7-2.

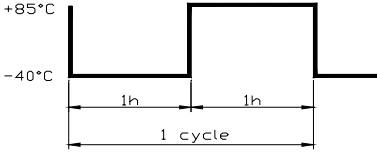
6-7	热冲击 Heat stock test	 <p>试验循环 /Test cycle :15 cycles</p>	<p>测试结果应符合项 7-2 的要求。 After the test motors shall be approved as specified in item 7-2.</p>
-----	------------------------	--	--

7. 要求/Requirements

项目/Item		判定基准 / Requirements	
7-1	表 A Table A	1) 额定转速/Rated speed : 2) 额定电流/Rated current : 3) 端阻/Terminal resistance : 4) 起动电压/Starting voltage : 5) 绝缘电阻/Insulation resistance :	不低于初始值-30%; 不高于初始值+50% data-30% Initial Min data+50% Initial Max 不低于初始值-30%; 不高于初始值+50% data-30% Initial Min data+50% Initial Max 不大于初始值±15% /Initial data±15% Max 不大于 2.5V 直流电压 2.5V DC Max :大于 10M Ω 10M Ω Min
7-2	表 B Table B	1) 额定转速/Rated speed : 2) 额定电流/Rated current : 3) 起动电压/Starting voltage : 4) 端阻/Terminal resistance :	不大于初始值±20% /Initial data±20% Max 不大于初始值±20% /Initial data±20% Max 不大于 2.5V 直流电压 2.5V DC Max 不大于初始值±15% /Initial data±15% Max

8. 使用时注意事项/Matters to be paid attention to when using motor

8-1 必须按照规格书标准使用,否则性能和寿命都将受到相当地减少, 必须注意电压的使用范围。

Unless it is used in accordance with the specifications ,the performance and life may be considerably reduced . Due attention should be paid to voltage and range for use .

8-2 建议马达在六个月内内使用,不要在以下环境中使用及保存:

1. 高温和高湿的场所;
2. 腐蚀性气体,如: H₂S、SO₂、NO₂、Cl₂;
3. 生锈场所。

Advice use this motor within 6 months as avoiding as possible.

Avoid use or save the motor in the following environment.

1. High temperature and high humidity area
2. Corrosive gas such as H₂S、SO₂、NO₂、Cl₂.
3. Dusty area .

8-3 注意处理马达的工作环境,避免含铁质等物体被马达吸住,否则马达将会产生噪声,性能会降低,从而减少产品可靠性。

Due attention must be paid to the handling and working environments because such objects as iron powder if attracted by the motor magnet,will cause noise,characteristic deterioration thus reducing the reliability.

8-4 应确信本产品不会与相关标准、法律、政令相背。

Please confirm enough no problem of standards and laws and ordinances on your cellular.

8-5 拿马达时,要轻拿轻放。

To handle the motor ,hold the motor case softly.

8-6 钢板面或边缘有少许锈斑是允许的。

Rust of plate(steel) and similar edge should be OK.

9.包装/PACKING

扁平系列马达包装
Pack drawing of coin type

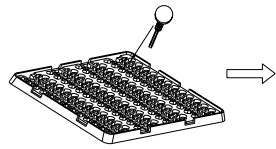

100PCS (1 tray) × 10

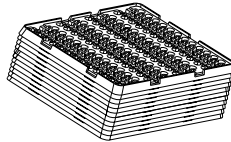

1000PCS (1 bundle)

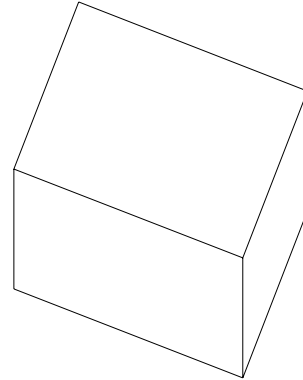

1 box × 2

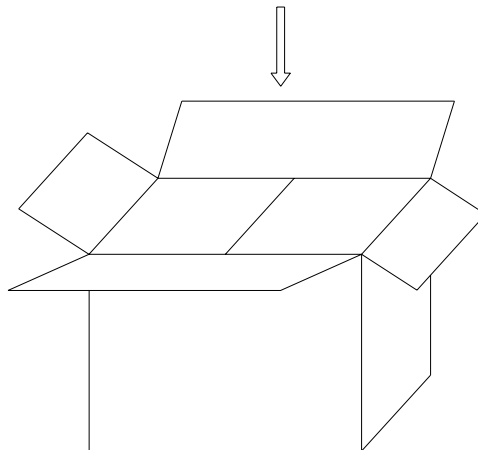

Remarks:
4000PCS/CTN: 45cm × 28cm × 20cm
6000PCS/CTN: 45cm × 28cm × 30cm

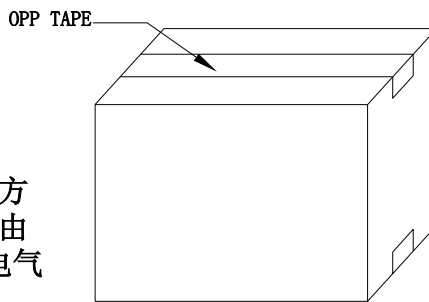

包装试验要求:
沿外包装箱±x, ±y和±z方向, 距水泥地面1.5m高度, 各自由
跌落2次, 马达应无机械损伤, 电气
性能仍符合标准要求。

金龙机电有限公司
技术开发部

10. 外形图/ OUTLINE VIEW

