



00-9175-002-001-006

PREFIX

SERIES

NO. OF WAYS

CODE	NO. OF WAYS
002	2
003	3

WIRE GAUGE SIZE

CODE	ACCEPTED WIRE GAUGE	WIRE INSULATION
001	28 GAUGE SOLID OR STRANDED 26 GAUGE SOLID OR STRANDED	MIN \varnothing 0.70 MAX \varnothing 1.00

PLATING OPTION

CODE	DESCRIPTION
006	PURE TIN ALL OVER

ELCO EUROPE (A DIVISION OF AVX LTD.) CONFIDENTIAL PROPRIETARY
THE DRAWING ON THIS PRINT AND INFORMATION THEREWITH ARE
PROPRIETARY TO ELCO EUROPE (A DIVISION OF AVX LTD.) AND
SHALL NOT BE USED OR DISCUSSED IN WHOLE OR IN PART
WITHOUT ELCO EUROPE'S WRITTEN CONSENT.

ELCO EUROPE (A DIVISION OF AVX LTD.) CONFIDENTIAL PROPRIETARY
THE DRAWING ON THIS PRINT AND INFORMATION THEREWITH ARE
PROPRIETARY TO ELCO EUROPE (A DIVISION OF AVX LTD.) AND
SHALL NOT BE USED OR DISCUSSED IN WHOLE OR IN PART
WITHOUT ELCO EUROPE'S WRITTEN CONSENT.

FORM-106-01-056-6 ISS 7
Release No.
History
102083

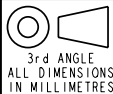

ELCO

© COPYRIGHT ELCO EUROPE
NOT TO BE DISCLOSED OR COPIED
WITHOUT WRITTEN PERMISSION

Drawn
GKJ

Size
CV

Description
IDC WIRE TO BOARD CONNECTOR

Part Number
00-9175-01S

DATE
04-Apr-06

Issue
C

2 WAY IDC CONNECTOR

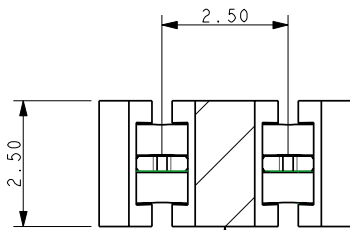

PICK UP AREA 1.18 x 2.50mm

NOTES:

1. CONNECTOR FOR IDC WIRE TO BOARD CONNECTION.
2. CONTACT MATERIAL : PHOSPHORE BRONZE.
3. INSULATION MATERIAL: HIGH TEMP NYLON 46.
4. CONNECTOR DESIGNED TO ACCEPT 26 AND 28 GAUGE SOLID OR STRANDED WIRE.
5. ALL DIMS FOR REFERENCE UNLESS OTHERWISE STATED.
6. FOR FULL PRODUCT SPECIFICATION REFER TO ELCO SPEC 201-01-100.

ELCO EUROPE (A DIVISION OF AVX LTD.) CONFIDENTIAL PROPRIETARY THE DRAWING ON THIS PRINT AND INFORMATION THEREWITH ARE PROPRIETARY TO ELCO EUROPE (A DIVISION OF AVX LTD.) AND SHALL NOT BE USED OR DISCUSSED IN WHOLE OR IN PART WITHOUT ELCO EUROPE'S WRITTEN CONSENT.

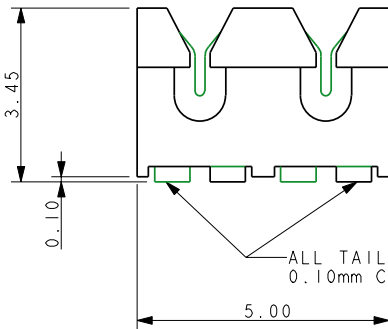

ALL TAILS TO BE WITHIN 0.10mm COPLANARITY TOLERANCE

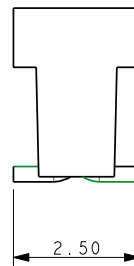

SMT PCB LAYOUT
PURE TIN PADS

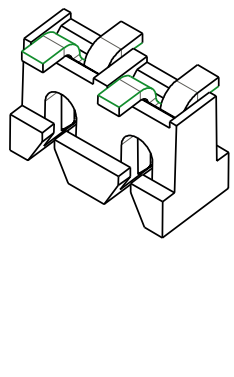
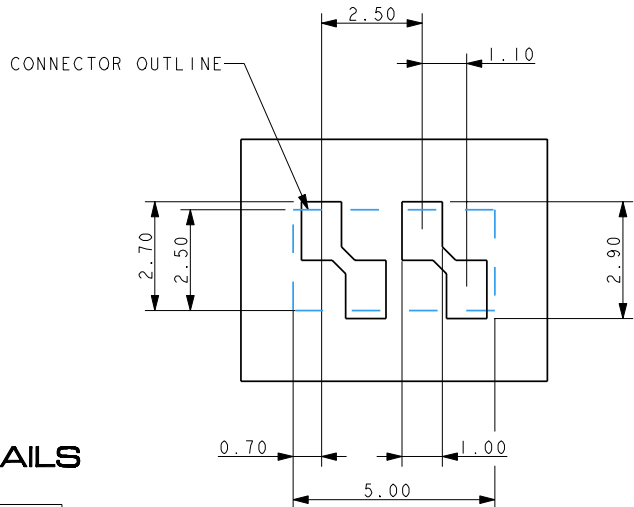

PACKING DETAILS

REEL QTY	2000
LEADER	500mm
TRAILER	500mm
REEL/BOX	7
PACK QTY	14000

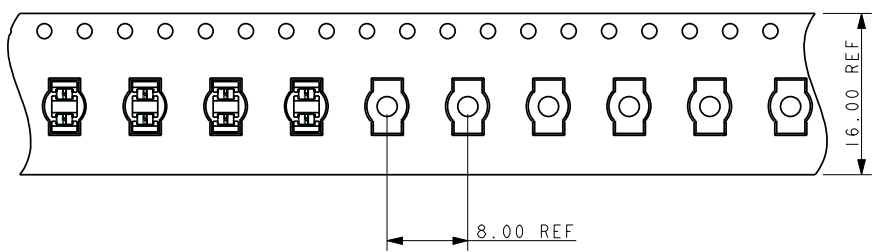
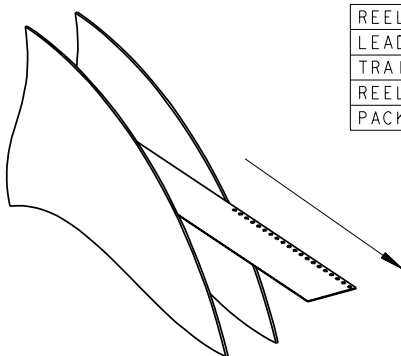

ELCO EUROPE (A DIVISION OF AVX LTD.) CONFIDENTIAL PROPRIETARY THE DRAWING ON THIS PRINT AND INFORMATION THEREWITH ARE PROPRIETARY TO ELCO EUROPE (A DIVISION OF AVX LTD.) AND SHALL NOT BE USED OR DISCUSSED IN WHOLE OR IN PART WITHOUT ELCO EUROPE'S WRITTEN CONSENT.

Release No. History 102083

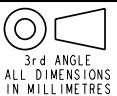

Drawn GKJ
Size CV

Description
IDC WIRE TO BOARD CONNECTOR
Part Number
00-9175-01S

DATE
04-Apr-06
Issue
C

FORM-106-01-056-6 ISS 7

3 WAY IDC CONNECTOR

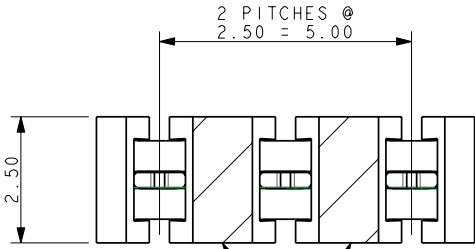

NOTES:

1. CONNECTOR FOR IDC WIRE TO BOARD CONNECTION.
2. CONTACT MATERIAL : PHOSPHORE BRONZE.
INSULATION MATERIAL : HIGH TEMP NYLON 46.
3. CONNECTOR DESIGNED TO ACCEPT 26 AND 28 GAUGE SOLID OR STRANDED WIRE.
4. ALL DIMS FOR REFERENCE UNLESS OTHERWISE STATED.
5. FOR FULL PRODUCT SPECIFICATION REFER TO ELCO SPEC 201-01-100.

ELCO EUROPE (A DIVISION OF AVX LTD.) CONFIDENTIAL PROPRIETARY THE DRAWING ON THIS PRINT AND INFORMATION THEREWITH ARE PROPRIETARY TO ELCO EUROPE (A DIVISION OF AVX LTD.) AND SHALL NOT BE USED OR DISCUSSED IN WHOLE OR IN PART WITHOUT ELCO EUROPE'S WRITTEN CONSENT.

PICK UP AREA 1.10 x 2.50mm

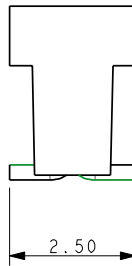
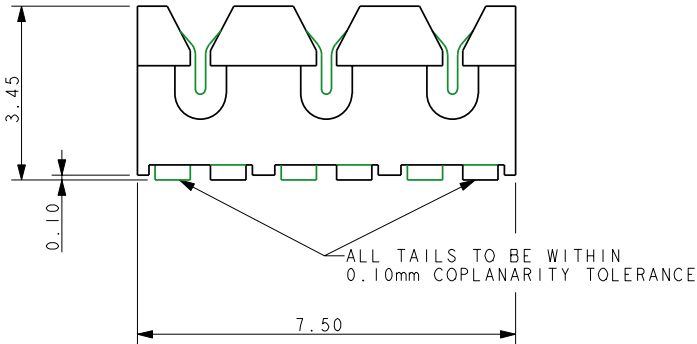

SMT PCB LAYOUT

PURE TIN PADS

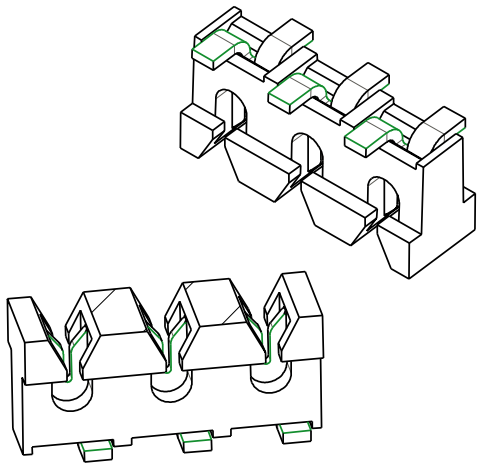
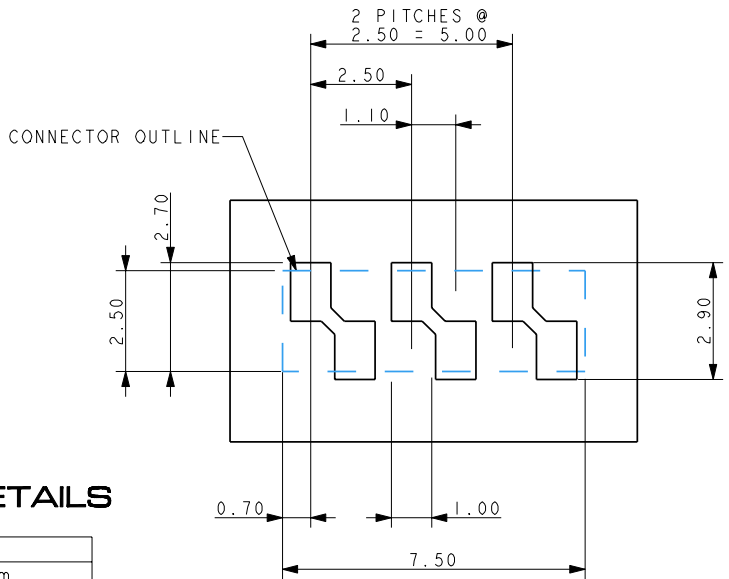

PACKING DETAILS

REEL QTY	2000
LEADER	500mm
TRAILER	500mm
REEL/BOX	7
PACK QTY	14000

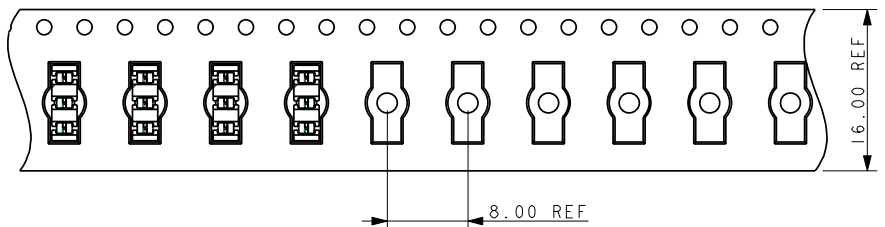
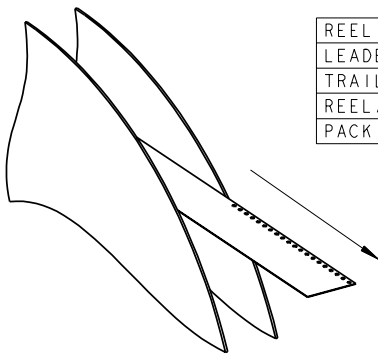

ELCO EUROPE (A DIVISION OF AVX LTD.) CONFIDENTIAL PROPRIETARY THE DRAWING ON THIS PRINT AND INFORMATION THEREWITH ARE PROPRIETARY TO ELCO EUROPE (A DIVISION OF AVX LTD.) AND SHALL NOT BE USED OR DISCUSSED IN WHOLE OR IN PART WITHOUT ELCO EUROPE'S WRITTEN CONSENT.

Release No.
History
102083

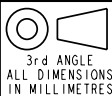

ELCO

© COPYRIGHT ELCO EUROPE
NOT TO BE DISCLOSED OR COPIED
WITHOUT WRITTEN PERMISSION

Drawn
GKJ
Size
CV

Description
IDC WIRE TO BOARD CONNECTOR
Part Number
00-9175-01S

DATE
04-Apr-06
Issue
C

FORM-106-01-056-6 ISS 7

HAND INSERTION TOOLING

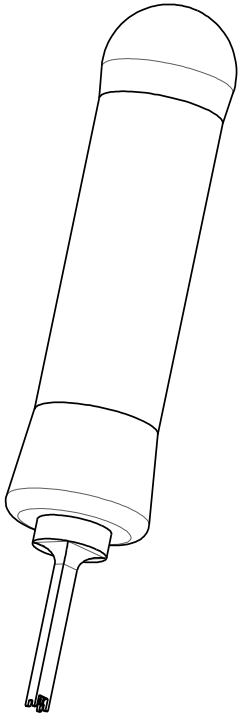

HIGH VOLUME

**SINGLE WIRE INSERTION TOOL
FOR 26/28 GAUGE WIRE**

06-9175-7002-01-000

[METAL]

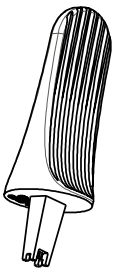

LOW VOLUME

**SINGLE WIRE INSERTION TOOL
FOR 26/28 GAUGE WIRE**

06-9175-7004-01-000

[PLASTIC]

ELCO EUROPE (A DIVISION OF AVX LTD.) CONFIDENTIAL PROPRIETARY
THE DRAWING ON THIS PRINT AND INFORMATION THEREWITH ARE
PROPRIETARY TO ELCO EUROPE (A DIVISION OF AVX LTD.) AND
SHALL NOT BE USED OR DISCUSSED IN WHOLE OR IN PART
WITHOUT ELCO EUROPE'S WRITTEN CONSENT.

ELCO EUROPE (A DIVISION OF AVX LTD.) CONFIDENTIAL PROPRIETARY
THE DRAWING ON THIS PRINT AND INFORMATION THEREWITH ARE
PROPRIETARY TO ELCO EUROPE (A DIVISION OF AVX LTD.) AND
SHALL NOT BE USED OR DISCUSSED IN WHOLE OR IN PART
WITHOUT ELCO EUROPE'S WRITTEN CONSENT.

FORM-106-01-056-6 ISS 7
Release No.
History
102083

3rd ANGLE
ALL DIMENSIONS
IN MILLIMETRES

ELCO

© COPYRIGHT ELCO EUROPE
NOT TO BE DISCLOSED OR COPIED
WITHOUT WRITTEN PERMISSION

Drawn
GKJ

Size
CV

Description
WIRE INSERTION TOOL

Part Number
00-9175-01S

DATE
04-Apr-06

Issue
C