

LL09 9-in-1 Lens for Color Mixing

Datasheet

For Edixeon® Multi-Color 9-in-1 and Single-Color LEDs

Features:

- High efficiency
- Available in 1 beam Patterns
- Optimized for color mixing effects
- Lens alone



Typical applications :

- Stage Lighting
- Street Lights
- Decorative Light
- Architectural Lighting
- Down Light



Table of Contents

• General Information.....	2
• General Specifications.....	3
• Optical Specifications.....	3
• Mechanical Specifications.....	4
• Illumination charts.....	6
• Package Specifications.....	7
• Product Nomenclature.....	8

General Information

• Compatible Led Type :

The LL09ED-AC25L lens are optimized for both Multi-Color RGB 3in1 Edixeon® LEDs (EDERTB-1LC6 and EDERTB-1EC1) and Single-Color Edixeon® LEDs from Edison Opto.⁽¹⁾

• Beam Angle Type :

An optimized profile integrate front shape enable the generation of one lens models:

Medium beam (25deg).⁽²⁾

• The Way to Assembly :

The lens should be assembled to the MCPCB or heat sink hole by the built-in three installation legs. The three installation legs ensure ideal relative position between the lens and LEDs resulting in the best optical performance.

***Hot Pressure and Ultrasonic Assembly process are recommended.**

• Function :

LL09ED-AC25L provides exceptional color mixing result with the highest efficiency through careful engineering and precision manufacturing process.

Notes:

(1) Edixeon® is a trademark of Edison Opto, for technical information on LEDs, please refer to Edison Opto website at www.edison-opto.com.tw.

(2) Typical beam divergence will be affected by different color of LEDs.

Notes:

- (3) The typical divergence will be changed by different color, chip size and chip position tolerance.
The typical total divergence is the full angle measured where the luminous intensity is half of the peak value.
- (4) The efficiency value listed above is the total value of the whole lens model, the value depends on the total flux of the LED used. Luminous intensity depends on the LEDs flux and its tolerances, for more details of LED flux, please check Edixeon® datasheet at www.edison-opto.com.tw.

Mechanical Specifications

• Usage and Maintenance :

1. If necessary, clean lenses with mild soap, water and soft cloth
2. Never use any commercial cleaning solvents on lenses, like alcohol
3. Please handle or install lenses with wearing gloves, skin oils may damage lens or its optical characteristic.

1. Lens + Leds+MCPCB assembly instruction:

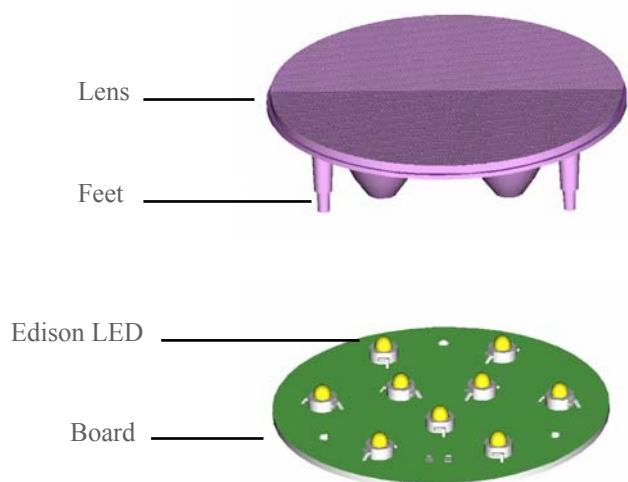

2. View assembly lens with MCPCB:

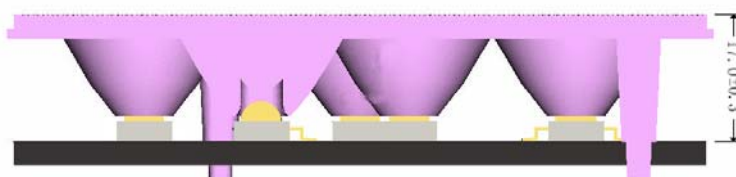

3. Multi-Color RTB Compatible MCPCB Dimensions:

4. Single-Color Compatible MCPCB Dimensions:

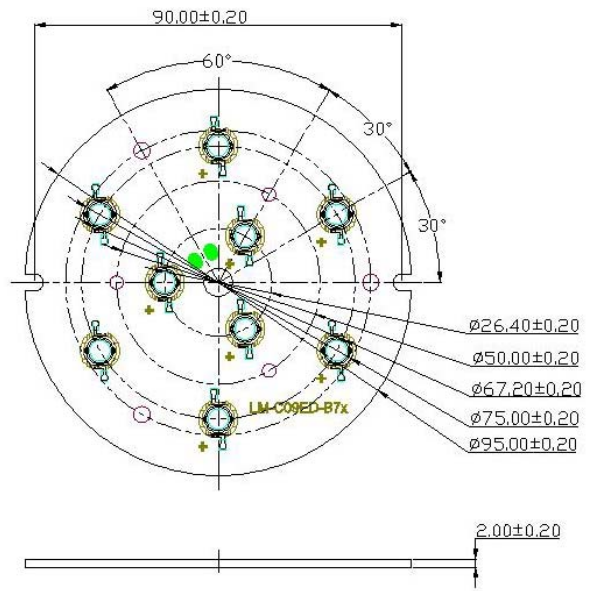
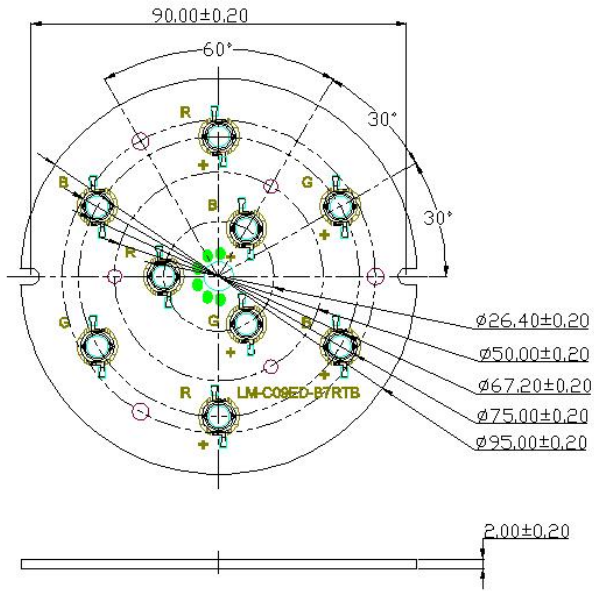

5. Lens assembly dimensions and Top Views :

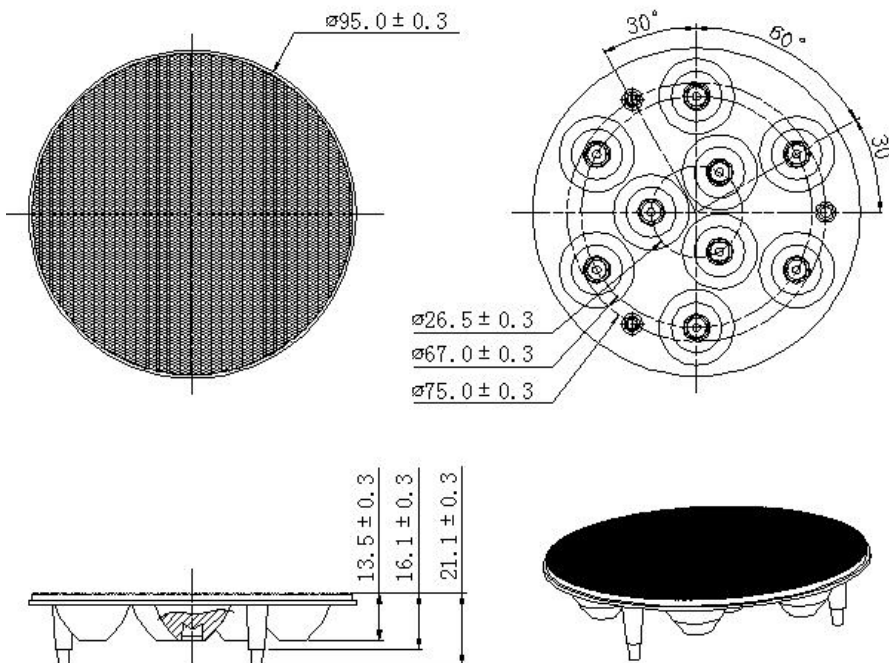

Notes:

- (1) All dimensions are in mm.
- (2) Drawing not to scale.
- (3) Collimator material is PMMA.

Illumination charts

*Edixeon® single white LED:EDEW-KLC8

LL09ED-AC25L

1. Beam Pattern



2. Angular Intensity Distribution

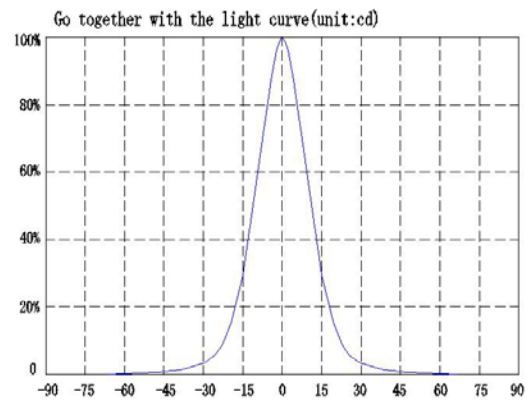

3. Shine on one degree diagram

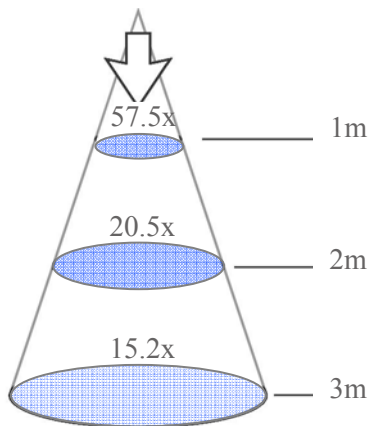

Package

Item	Quantity	Total	Size (long * width * high)
Floar		9 pcs	38*36cm
Inner box	5 Floar/box	45pcs	40*37*21 cm
Outer box	2 inner box/outer box	90pcs	45.5*42*39cm

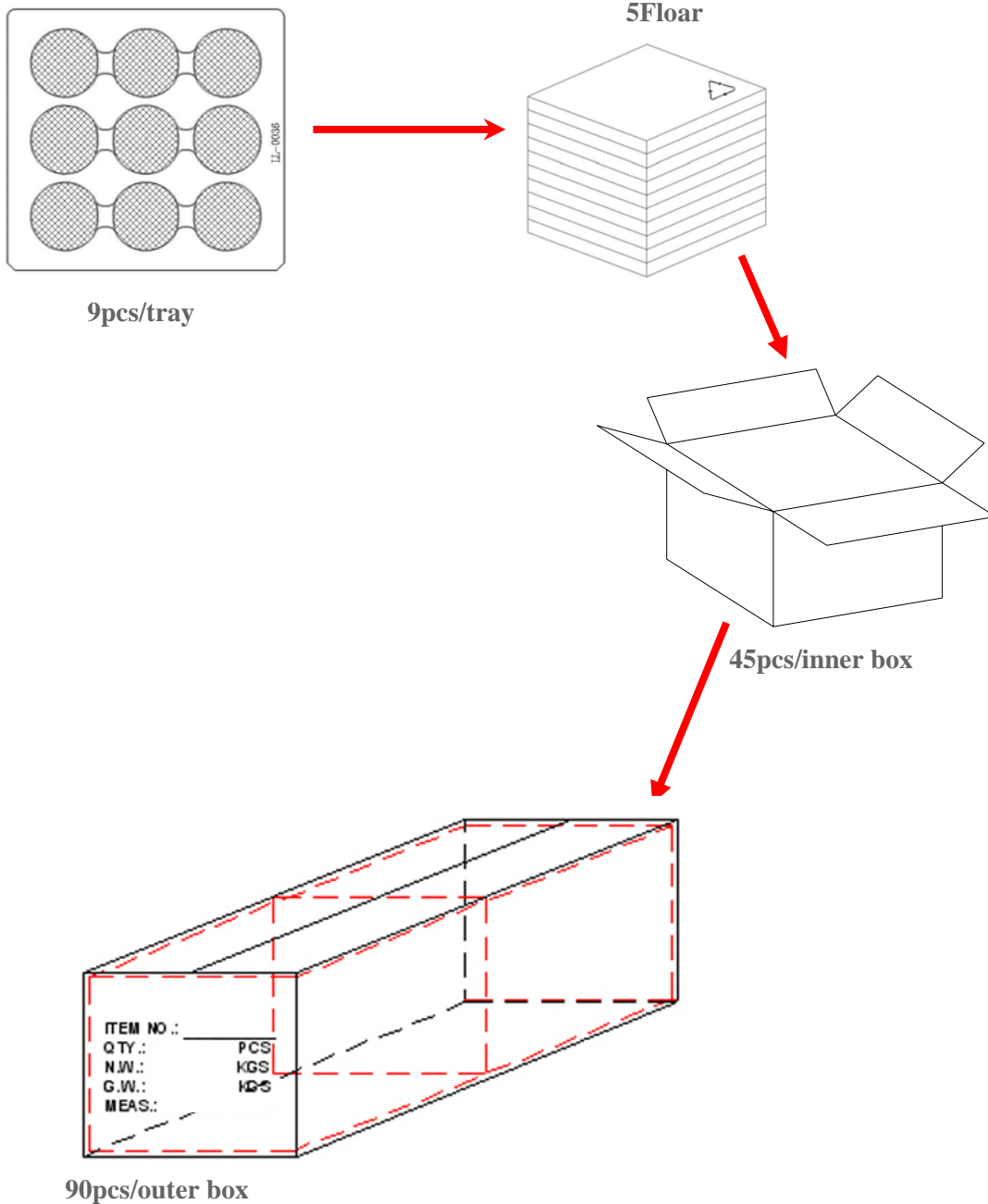

Product Nomenclature

