

REV. A	ECN NO.	DATE Initial Release 2010/07/27	SIGN Doreen	DESCRIPTION Change REV.01 to REV.A

THIS DOCUMENT IS SUBJECT TO CHANGE WITHOUT NOTICE. IT IS CONFIDENTIAL AND A PROPERTY OF Amphenol LTW. DISCLOSURE TO THIRD PARTY HAS TO BE AUTHORIZED BY Amphenol LTW.

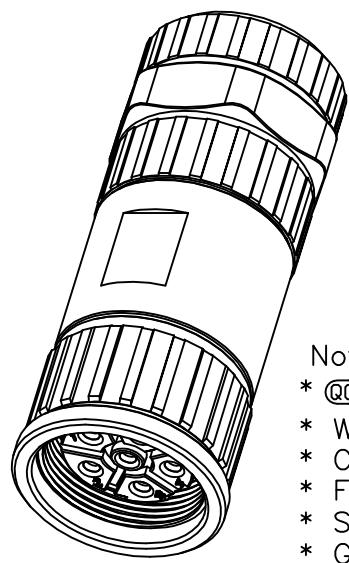
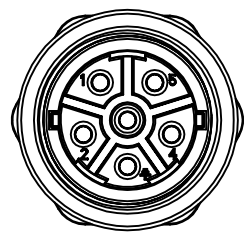
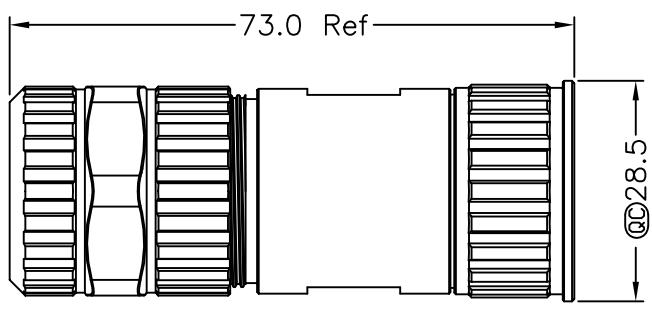
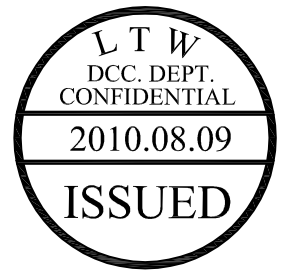
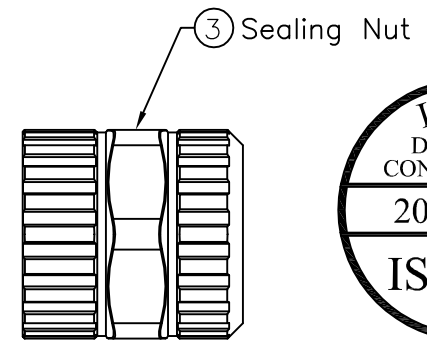
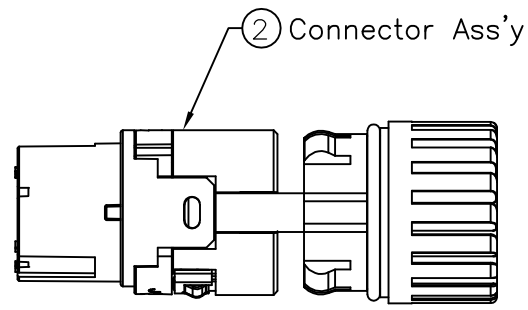
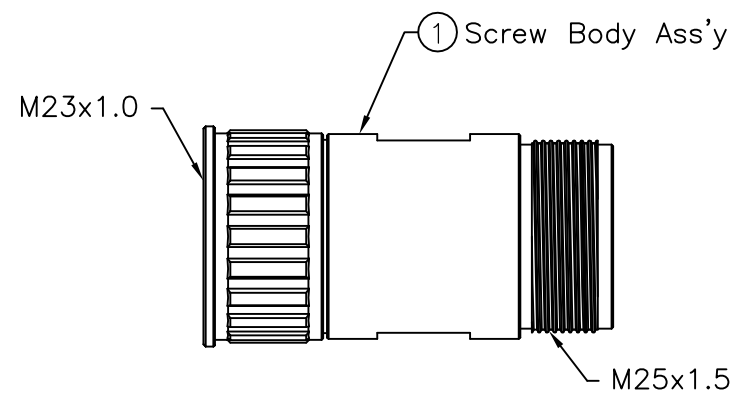

- Note:
- * @@ Important Dimension.
 - * Waterproof Rate: IP67.
 - * Connector: Nylon, Black.
 - * Female Pin: Copper Alloy, Gold Plated.
 - * Screw Nut: Copper Alloy, Nickel Plated.
 - * Gasket: Silicone, UL94V-0, Gray
 - * Recommended Gauge: 14Awag, 12 Awg
 - * Cable OD: B1: Ø8.5~Ø12mm ; B2: Ø12~Ø17.5mm

UNIT:mm	
TOLERANCE	
.X	±0.25
.XX	±0.1
.XXX	±0.05
ANGLES	±1°

TITLE	M23 Panel ASS'Y Type, F CON, F PIN		
SCALE	Free	SHEET	1 OF 2
REV. A	SIZE A4	@ : Inspection Item	

Amphenol LTW
安費諾亮泰企業股份有限公司

ITEM NO	LJ23-06DFFC-SL7001
DWG NO	LJ23-06DFFC-SL7001
CUSTOMER	ALTW

DRAWN BY	Doreen
CHECKED BY	Winnie
APPROVED BY	Kevin

DATE	2010/08/02
DATE	2010/08/02
DATE	2010/08/02

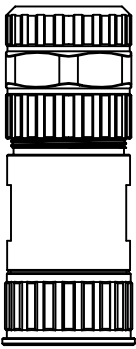
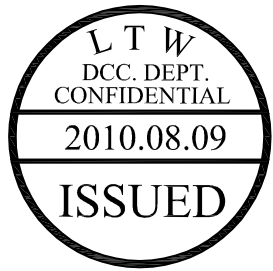

(A包裝)

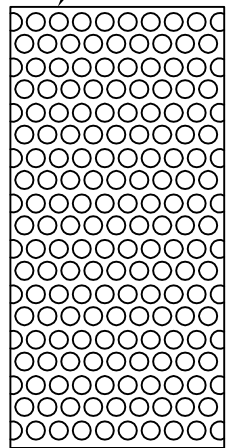

⑥ Bubble Bag

Female Pin ④

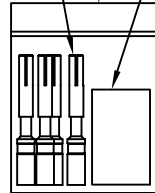

(B包裝)

⑦ 1號由任袋

⑤ Gasket B1

REV. A	ECN NO.	DATE	SIGN	DESCRIPTION
		Initial Release 2010/07/27	Doreen	Change REV.01 to REV.A

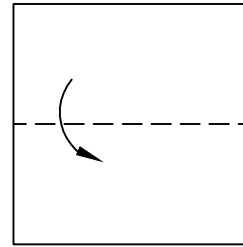

第一折

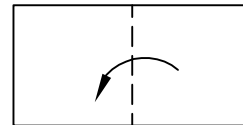

第二折

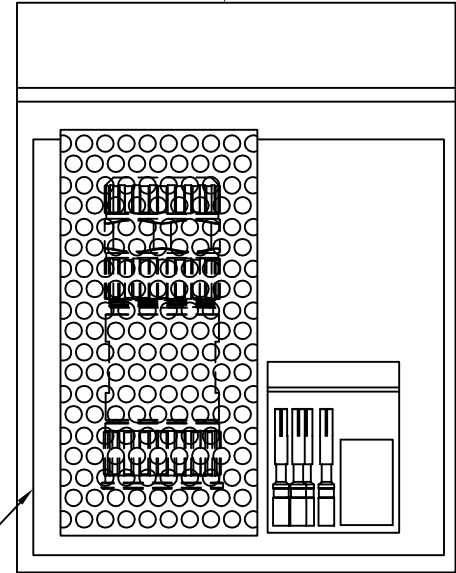

⑧ 6號由任袋

⑨ 組裝說明書



包裝方式

A包裝: 將 ① ② ③ 組裝完成後裝入 ⑥ 氣泡袋中

B包裝: 將 ④ ⑤ 裝入 ⑦ 1號由任袋中

最後將 A 包裝與 B 包裝及 ⑨ 組裝說明書一同裝入 ⑧ 6號由任袋中, 即放入紙箱

UNIT:mm	
TOLERANCE	
.X	±0.25
.XX	±0.1
.XXX	±0.05
ANGLES	±1'

TITLE		M23 Panel ASS'Y Type, F CON, F PIN	
SCALE	Free	SHEET	2 OF 2
REV. A	SIZE A4	◎ : Inspection Item	

Amphenol LTW
安費諾亮泰企業股份有限公司

ITEM NO	LJ23-06DFFC-SL7001
DWG NO	LJ23-06DFFC-SL7001
CUSTOMER	ALTW

DRAWN BY	Doreen
CHECKED BY	Winnie
APPROVED BY	Kevin

DATE	2010/08/02
DATE	2010/08/02
DATE	2010/08/02

THIS DOCUMENT IS SUBJECT TO CHANGE WITHOUT NOTICE. IT IS CONFIDENTIAL AND A PROPERTY OF Amphenol LTW. DISCLOSURE TO THIRD PARTY HAS TO BE AUTHORIZED BY Amphenol LTW.